

SPEC. NO.

TQ3C-8EAF0-E1DDE09-00

DATE

September 29, 2004

S P E C

FOR : _____

TYPE : TCG057QV1AD-G00

CONTENTS

1. Application
2. Construction and Outline
3. Mechanical Specifications
4. Absolute Maximum Ratings
5. Electrical Characteristics
6. Optical Characteristics
7. Interface Signals
8. Timing Characteristics of input signals
9. Backlight Characteristics
10. Design Guidance for Analog Touch-Panel(T/P)
11. Lot Number Identification
12. Warranty
13. Precautions for Use
14. Reliability Data / Environmental Test
15. Outline Drawing

Issued

Date: OCT.07.2004



Hayato LCD Division

KYOCERA CORPORATION
KAGOSHIMA HAYATO PLANT
LCD DIVISION

This specification is subject to change without notice.
Consult Kyocera before ordering.

| | | | | | |
|--------------------|--------------------------------|---------------------|--------------------|------------------------|------------------|
| Original | Designed by :Engineering Dept. | | | Confirmed by :QA Dept. | |
| Issue Data | Prepared | Checked | Approved | Checked | Approved |
| September 29, 2004 | <i>T. Onodera</i> | <i>J. Yamaguchi</i> | <i>M. Fujitani</i> | <i>Y. Yoshida</i> | <i>T. Minami</i> |

Caution

1. This Kyocera LCD module has been specifically designed for use only in electronic devices in the areas of audio control, office automation, industrial control, home appliances, etc. The modules should not be used in applications where module failure could result in physical harm or loss of life, and Kyocera expressly disclaims any and all liability relating in any way to the use of the module in such applications.
2. Customer agrees to indemnify, defend and hold Kyocera harmless from and against any and all actions, claims, losses, damages, liabilities, awards, costs, and expenses, including legal fees, resulting from or arising out of Customer's use, or sale for use, of Kyocera modules in applications.
3. Kyocera shall have the right, which Customer hereby acknowledges, to immediately scrap or destroy tooling for Kyocera modules for which no Purchase Orders have been received from the Customer in a two-year period.

Revision Record

| Date | Designed by: Engineering Dept. | | | Confirmed by: QA Dept. | |
|----------|--------------------------------|---------|--------------|------------------------|----------|
| | Prepared | Checked | Approved | Checked | Approved |
| | | | | | |
| Rev. No. | Date | Page | Descriptions | | |
| | | | | | |

1. Application

This data sheet defines the specification for a $(320 \times R.G.B) \times 240$ dot, amorphous silicon TFT transmissive color dot matrix type Liquid Crystal Display with CFL backlight.

2. Construction and Outline

$(320 \times R.G.B) \times 240$ dots, COG type LCD with CFL backlight.

Backlight system : "U" figured type CFL (1 tube).

Inverter : Option.
Recommended Inverter : CXA-L0612A-VJL (TDK)
or Equivalent.

Polarizer : Glare treatment.

Additional circuits : Timing controller, Power supply (3.3V input)

Touch Panel : Analog type. Non-Grare treatment.

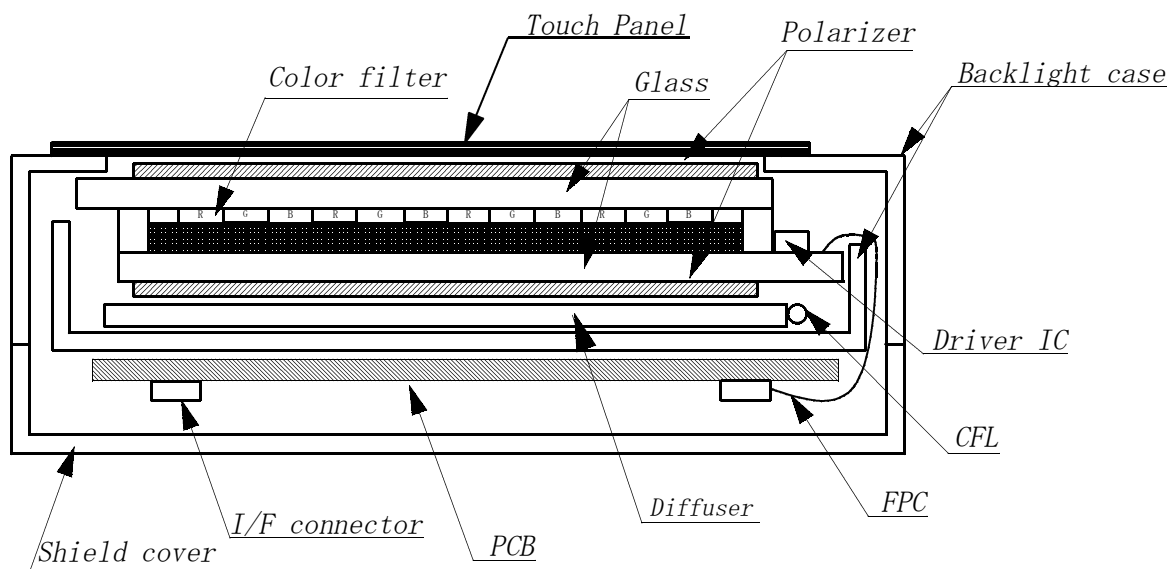

This drawing is showing conception only.

3. Mechanical Specifications

| ITEM | SPECIFICATION | UNIT |
|------------------------|------------------------------------|------|
| Outline dimensions | 144.0 (W) × (104.8) (H) × 14.8 (D) | mm |
| Effective viewing area | 117.2 (W) × 88.4 (H) | mm |
| Dot number | (320×R. G. B) (W) × 240 (H) | Dots |
| Dot pitch | 0.12 (W) × 0.36 (H) | mm |
| Display mode *1 | Normally white | — |
| Mass | 260 | g |

*1 Due to the characteristics of the LCD material, the color vary with environmental temperature.

3-2. Mechanical Specifications of touch panel

| ITEM | SPECIFICATION | UNIT |
|------------------|--------------------------------------|------|
| Input | Radius-0.8 stylus or Finger | — |
| Actuation Force | 0.5N±0.3N | g |
| Transmittance | Typ. 80 | % |
| Surface hardness | pencil hardness 2H or more according | — |

4. Absolute Maximum Ratings

4-1. Electrical absolute maximum ratings

| ITEM | SYMBOL | Min. | Max. | UNIT |
|----------------------------|--------|------|------|------|
| Power input voltage | VDD | 0 | 4.0 | V |
| Input signal voltage *1 | Vin | -0.3 | 6.0 | V |
| Touch panel supply voltage | Vtp | 0 | 6.0 | V |
| Touch panel Input current | Itp | 0 | 0.5 | mA |

*1 Input signals : CK, R0~R5, G0~G5, B0~B5, Hsync, Vsync, ENAB, R/L, U/D, V/Q

4-2. Environmental absolute maximum ratings

| ITEM | SYMBOL | Min. | Max. | UNIT |
|--------------------------|--------|------|------|------|
| Operating temperature *1 | Top | -10 | 70 | °C |
| Storage temperature *2 | Tsto | -30 | 80 | °C |
| Operating humidity *3 | Hop | 10 | *4 | %RH |
| Storage humidity *3 | Hsto | 10 | *4 | %RH |
| Vibration | — | *5 | *5 | — |
| Shock | — | *6 | *6 | — |

*1 Operating temperature means a temperature which operation shall be guaranteed.
 Since display performance is evaluated at 25°C, another temperature range should be confirmed.

*2 Temp. = -30 °C < 48 h , Temp = 80 °C < 168 h
 Store LCD panel at normal temperature/humidity.
 Keep it free from vibration and shock.
 LCD panel that is kept at low or high temperature for a long time can be defective due to the other conditions, even if the temperature satisfies standard.
 (please refer to 13. Precautions for use as detail).

*3 Non-condensation.

*4 Temp. ≤ 40°C, 85%RH Max.
 Temp. > 40°C, Absolute Humidity shall be less than 85% RH at 40°C.

*5

| | | |
|-----------------|----------------------|---|
| Frequency | 10~55 Hz | Converted to acceleration value : (0.3~9 m/s ²) |
| Vibration width | 0.15 mm | |
| Interval | 10-55-10 Hz 1 minute | |

2 hours in each direction X/Y/Z (6 hours as total)
 EIAJ ED-2531

*6 Acceleration: 490m/s²
 Pulse width : 11 ms
 3 times in each direction : ±X/±Y/±Z.
 EIAJ ED-2531

5. Electrical Characteristics

5-1. LCD

| ITEM | SYMBOL | MIN | TYP | MAX | UNIT | |
|--|----------|--------|-----|--------|-------|----|
| Power input voltage *1 | VDD=3.3V | VDD | 3.0 | 3.3 | 3.6 | V |
| Current consumption *2 | | IDD | — | 130 | 160 | mA |
| Permissive input ripple voltage (VDD=3.3V) | VRP | — | — | 100 | mVp-p | |
| Input signal voltage (Low) *3 | VIL | 0 | — | 0.3VDD | V | |
| Input signal voltage (High) *3 | VIH | 0.7VDD | — | +5.5 | V | |

*1 VDD-turn-on conditions

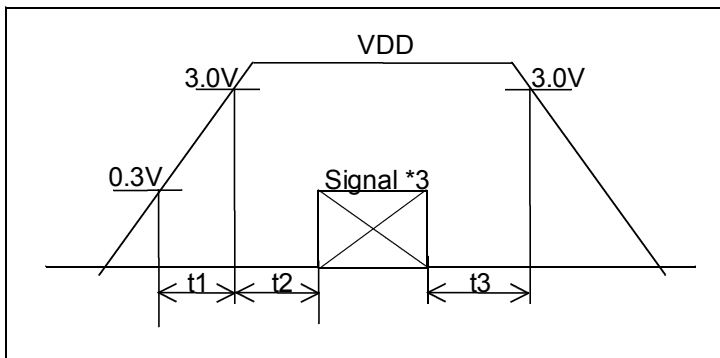

$$0 < t_1 \leq 20 \text{ ms}$$

$$0 < t_2 \leq 50 \text{ ms}$$

$$0 < t_3 \leq 1 \text{ s}$$

*2 Power consumption

Black & White pattern :

VDD = 3.3V, V/Q=H

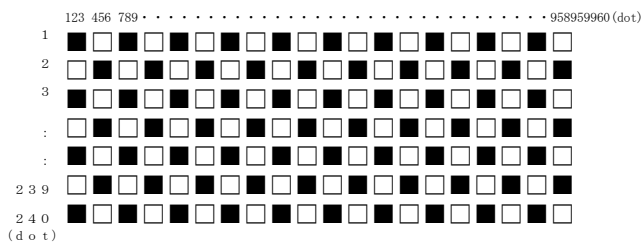

*3 Input signals : CK, R0~R5, G0~G5, B0~B5, Hsync, Vsync, ENAB, R/L, U/D, V/Q

5-2. Touch Panel

5-2-1. Terminal resistance

Between xL and xR : 200 ~ 1000 Ω

Between yU and yL : 200 ~ 1000 Ω

5-2-2. Linearity

±1.5%

5-2-3. Insulation resistance

100MΩ or more at DC25V

6. Optical Characteristics

Measuring points = ϕ 6.0mm , Temp. = 25°C

| ITEM | | SYMBOL | CONDITION | MIN | TYP | MAX | UNIT | |
|---------------------------|-------|----------|---------------------------|-------|-------|-------|-------------------|------|
| Response time | Rise | τr | $\theta = \phi = 0^\circ$ | — | 10 | — | ms | |
| | Down | τd | $\theta = \phi = 0^\circ$ | — | 25 | — | ms | |
| Viewing angle range | | θ | $CR \geq 5$ | Upper | — | 70 | — | deg. |
| | | | | Lower | — | 50 | — | |
| | | ϕ | | Left | — | 70 | — | deg. |
| | | | | Right | — | 70 | — | |
| Contrast ratio | | CR | $\theta = \phi = 0^\circ$ | 300 | 450 | — | — | |
| Brightness (IL=4.0mArms.) | | L | | 240 | 370 | — | cd/m ² | |
| Chromaticity coordinates | Red | x | $\theta = \phi = 0^\circ$ | 0.557 | 0.607 | 0.657 | — | |
| | | y | | 0.293 | 0.343 | 0.393 | | |
| | Green | x | $\theta = \phi = 0^\circ$ | 0.253 | 0.303 | 0.353 | | |
| | | y | | 0.495 | 0.545 | 0.595 | | |
| | Blue | x | $\theta = \phi = 0^\circ$ | 0.099 | 0.149 | 0.199 | | |
| | | y | | 0.070 | 0.120 | 0.170 | | |
| | White | x | $\theta = \phi = 0^\circ$ | 0.261 | 0.311 | 0.361 | | |
| | | y | | 0.268 | 0.318 | 0.368 | | |

6-1. Contrast ratio is defined as follows:

$$CR = \frac{\text{Brightness at all pixels "White"}}{\text{Brightness at all pixels "Black"}}$$

6-2. Definition of viewing angle

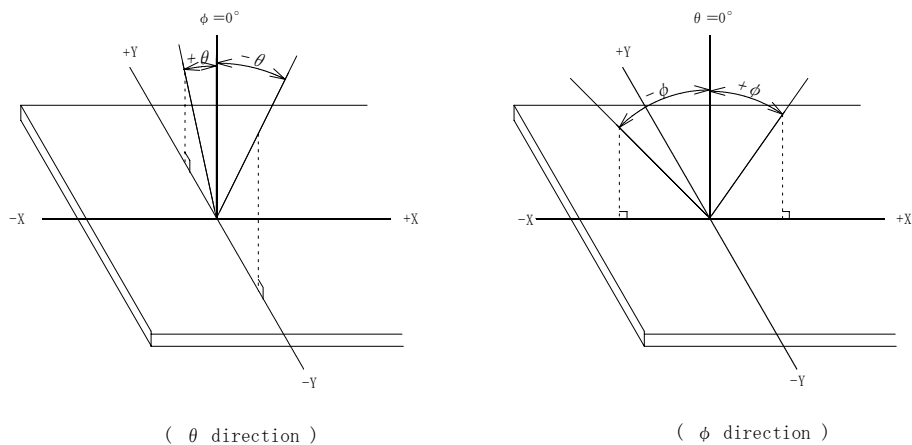

6-3. Measuring points

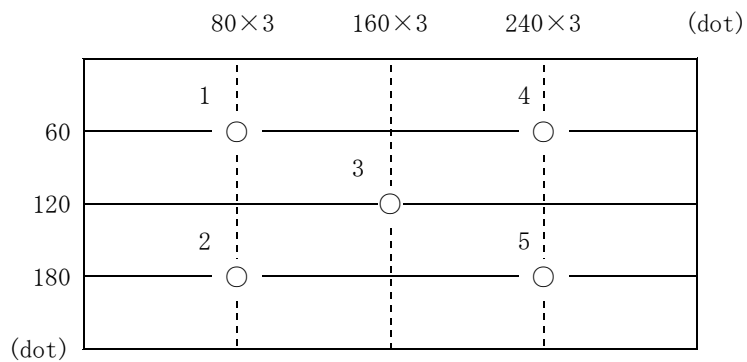

- 1) Rating is defined as the average brightness inside the viewing area.
- 2) 30 minutes after CFL is turned on. (Ambient Temp.=25°C)
- 3) The inverter should meet the eccentric conditions;
 - Sine, symmetric waveform without spike in positive and negative.

7. Interface signals

7-1. LCD

| PIN NO. | SYMBOL | DESCRIPTION | I/O | Note |
|---------|--------|---|-----|------|
| 1 | GND | GND | - | |
| 2 | CK | Clock signal for sampling each data signal | I | |
| 3 | Hsync | Horizontal synchronous signal (negative) | I | |
| 4 | Vsync | Vertical synchronous signal (negative) | I | |
| 5 | GND | GND | - | |
| 6 | R0 | RED data signal (LSB) | I | |
| 7 | R1 | RED data signal | I | |
| 8 | R2 | RED data signal | I | |
| 9 | R3 | RED data signal | I | |
| 10 | R4 | RED data signal | I | |
| 11 | R5 | RED data signal (MSB) | I | |
| 12 | GND | GND | - | |
| 13 | G0 | GREEN data signal (LSB) | I | |
| 14 | G1 | GREEN data signal | I | |
| 15 | G2 | GREEN data signal | I | |
| 16 | G3 | GREEN data signal | I | |
| 17 | G4 | GREEN data signal | I | |
| 18 | G5 | GREEN data signal (MSB) | I | |
| 19 | GND | GND | - | |
| 20 | B0 | BLUE data signal (LSB) | I | |
| 21 | B1 | BLUE data signal | I | |
| 22 | B2 | BLUE data signal | I | |
| 23 | B3 | BLUE data signal | I | |
| 24 | B4 | BLUE data signal | I | |
| 25 | B5 | BLUE data signal (MSB) | I | |
| 26 | GND | GND | - | |
| 27 | ENAB | Signal to settle the horizontal display position (positive) | I | *1 |
| 28 | VDD | 3.3V power supply | - | |
| 29 | VDD | 3.3V power supply | - | |
| 30 | R/L | Horizontal display mode select signal L : Normal , H : Left / Right reverse mode | I | *2 |
| 31 | U/D | Vertical display mode select signal H : Normal , L : Up / Down reverse mode | I | *2 |
| 32 | V/Q | VGA / QVGA mode select signal | I | |
| 33 | GND | GND | - | |

*1 The horizontal display start timing is settled in accordance with a rising timing of ENAB signal.
In case ENAB is fixed "Low", the horizontal start timing is determined as described in 8-2.
Don't keep ENAB "High" during operation.

*2

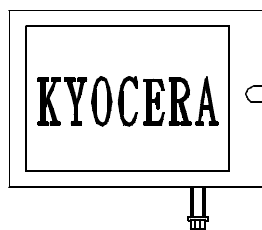

R/L = L
U/D = H

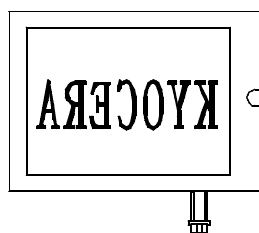

R/L = H
U/D = H



R/L = L
U/D = L

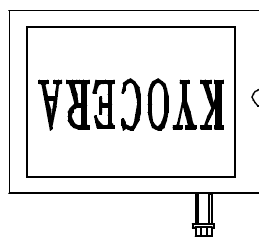

R/L = H
U/D = L

7-2. CFL

| PIN NO. | SYMBOL | DESCRIPTION |
|---------|--------|-----------------------------------|
| 1 | HOT | Inverter output high voltage side |
| 2 | NC | — |
| 3 | COLD | Inverter output low voltage side |

LCD side connector : BHR-03VS-1 (JST)

Recommended matching connector : SM02-(8.0)B-BHS-1 (JST)

* Please be careful NOT to connect inversely an inverter-output high voltage side to the CFL low voltage side. It may result in damage or electric shock.

7-3. Touch panel

| PIN No. | SYMBOL | DESCRIPTION |
|---------|--------|------------------|
| 1 | yU | y-Upper terminal |
| 2 | xL | x-Left terminal |
| 3 | yL | y-Lower terminal |
| 4 | xR | x-Right terminal |

8. Timing Characteristics of input signals

8-1. Timing characteristics

| ITEM | | SYMBOL | MIN | TYP | MAX | UNIT | NOTE |
|--------------------------------------|-------------|--------|------|-------|--------|---------|-------|
| Clock | Frequency | 1/Tc | — | 25.18 | 28.33 | MHz | V/Q=H |
| | | | | 6.3 | 7.0 | | V/Q=L |
| | Duty ratio | Tch/Tc | 40 | 50 | 60 | % | |
| Data | Set up time | Tds | 5 | — | — | ns | |
| | Hold time | Tdh | 10 | — | — | ns | |
| Horizontal sync. signal | Cycle | TH | 30.0 | 31.8 | — | μs | V/Q=H |
| | | | 770 | 800 | 900 | clock | |
| | | TH | 50.0 | 63.6 | — | μs | V/Q=L |
| | | | 360 | 400 | 450 | clock | |
| | Pulse width | THp | 2 | 96 | 200 | clock | |
| Vertical sync. signal | Cycle | TV | 515 | 525 | 560 | line | V/Q=H |
| | | TV | 251 | 262 | 280 | | V/Q=L |
| | Pulse width | TVp | 2 | — | 34 | line | |
| Horizontal display period | | THd | 320 | | | clock | |
| Hsync.-Clock phase difference | | THc | 10 | — | Tc-10 | ns | |
| Hsync.-Vsync. phase difference | | TVh | 0 | — | TH-THp | ns | |
| Vertical sync. signal start position | | TVs | 34 | | | line | V/Q=H |
| | | | 7 | | | | V/Q=L |
| Vertical display period | | TVd | 240 | | | line | |

*In case of lower frequency, the deterioration of the display quality, flicker etc., may occur.

8-2. Horizontal display position

The horizontal display position is determined by ENAB signal.

| ITEM | | SYMBOL | MIN | TYP | MAX | UNIT | NOTE |
|--|-------------|--------|-----|-----|--------|-------|-------|
| Enable signal | Set up time | Tes | 5 | — | Tc-10 | ns | |
| | Pulse width | Tep | 2 | 320 | TH-10 | clock | |
| Hsync. -Enable signal phase difference | | The | 44 | — | TH-664 | clock | V/Q=H |
| | | | 2 | — | TH-340 | | V/Q=L |

*When ENAB is fixed at "V/Q=H", the display starts from the data of C104 (clock) as shown in 8-5.

*When ENAB is fixed at "V/Q=L", the display starts from the data of C52 (clock) as shown in 8-5.

8-3. Vertical display position

The vertical display position (TVs) is fixed at 34th line (V/Q=H) and 7th line (V/Q=L).

Note) ENAB signal is independent of vertical display position.

8-4. Input Data Signals and Display position on the screen

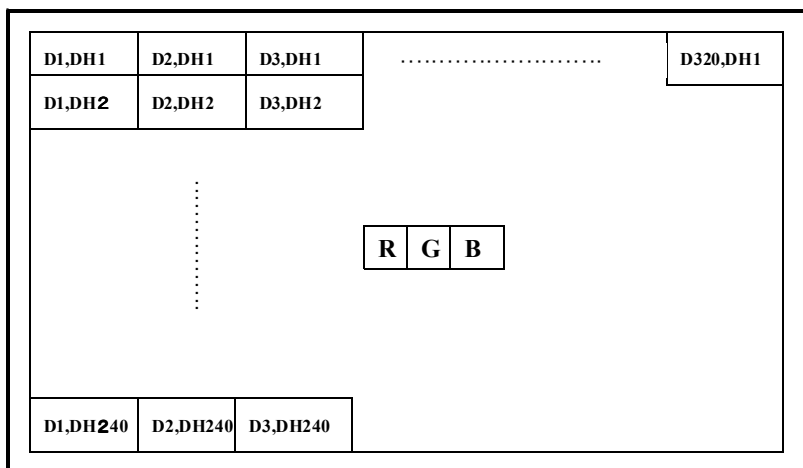

8-5. Input Timing Characteristics

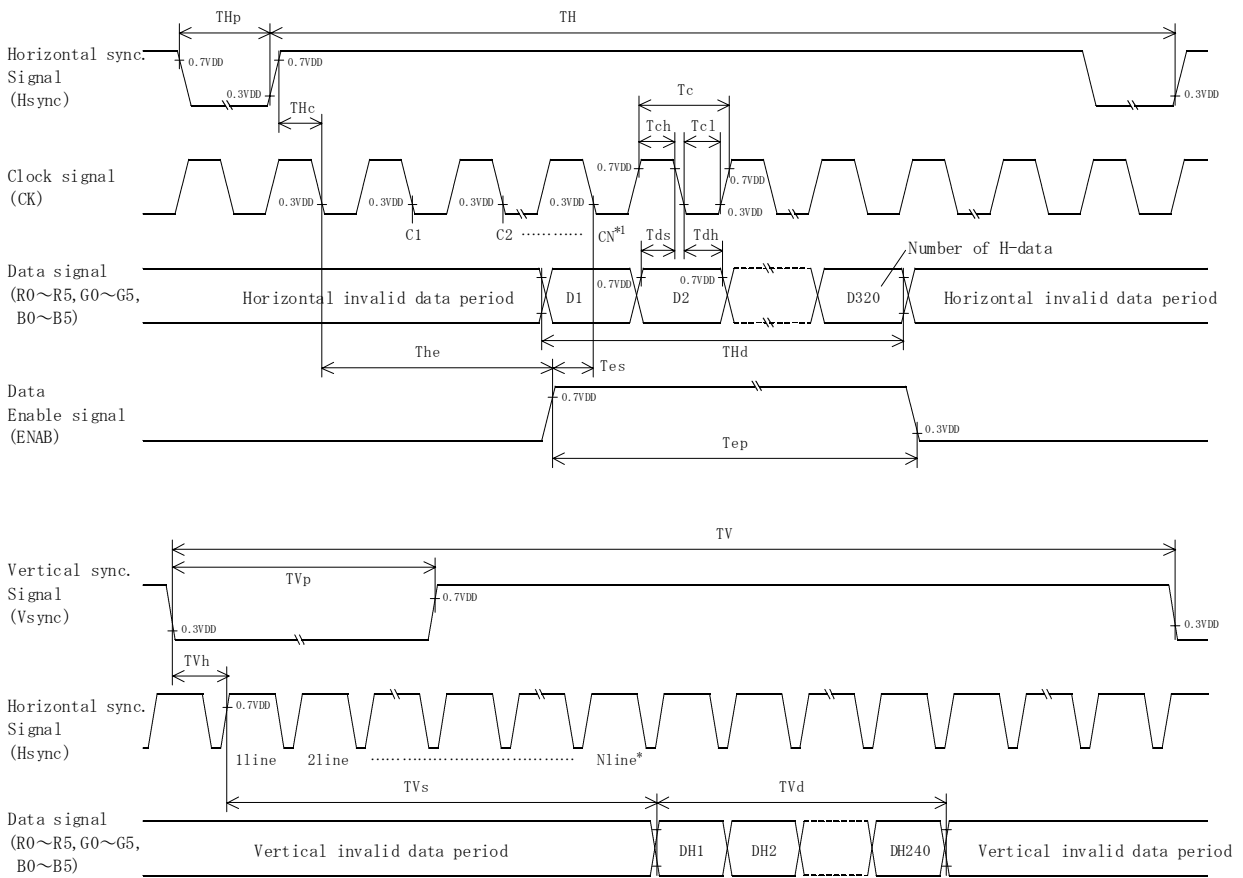

*1 When ENAB is fixed at V/Q="H", the display starts from the data of C104(Clock).
When ENAB is fixed at V/Q="L", the display starts from the data of C52(Clock).

*2 The vertical display position (TVs) is fixed at 34th line (V/Q=H) and 7th line (V/Q=L).

9. Backlight Characteristics

Temp. = 25°C

| ITEM | SYMBOL | MIN. | TYP. | MAX. | NOTE |
|------------------------------------|--------|---------------|---------------|---------------|--------|
| Starting discharge Voltage *1 | VS | — | — | (1,550) Vrms. | -10 °C |
| | | — | — | (1,035) Vrms. | 25 °C |
| Discharging tube current *2,*3 | IL | (3.0) mA rms. | (4.0) mA rms. | (5.0) mA rms. | — |
| Discharging tube voltage | VL | — | (685) Vrms. | — | — |
| Operating life (IL=4.0 mA rms.) *4 | T | (60,000 h) | (75,000 h) | — | — |
| Operating frequency | F | (30) kHz | — | (100) kHz | — |

- *1 The Non-load output voltage (VS) of the inverter should be designed to have some margin, because VS may increase due to the leak current which may be caused by wiring of CFL cables. (Reference value : (2,015) Vrms Min.)
- *2 We recommend that you should set the discharging tube current at lower than typical value so as to prevent the heat accumulation of CFL tube from deteriorating a performance of the LCD.
- *3 Do not apply more than 6.0 mA discharging tube current. Because CFL maybe broken due to over current.
- *4 When the illuminance or quantity of light has decreased to 50 % of the initial value. Average life time of CFL will be decreased when LCD is operating at lower and higher temperature.
- *5 There may be a case that an interference noise between an input signal frequency of LCD and a brightness adjustment frequency of a backlight inverter is appeared. Please set the brightness adjustment frequency of a backlight inverter not to appear the interference noise.

* CFL arrangement figure

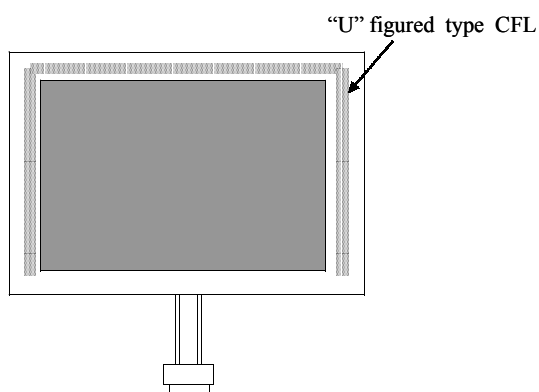

1 0. Design Guidance for Analog Touch-Panel(T/P)

10-1. Electrical

In customer's design, please remember the following considerations.

1. Do not use the current regulated circuit.
2. Keep the current limit with top and bottom layer. (See Sec, 4-1)
3. Analog T/P can not sense two point touching separately.
4. A contact resistance is appeared at the touch point between top and bottom layer.
After this resistance has stable read the T/P position data.
5. Analog T/P is also a "Capacitor" in an equivalent circuit.
Design your sensing circuit and low-pass filter with considering this "Capacitor" value.
6. Because noise of inverter or peripheral circuits may interfere signal of touch panel itself it is necessary to design carefully in advance to avoid these noise problem.

10-2. Software

1. Do the "User Calibration".
2. "User Calibration" may be needed with long term using.
Include "User Calibration" menu in your software.
3. When drawing a line with a stylus, there may be a slight discontinuity when the stylus passes over a spacer-dot. If necessary, please provide a compensation feature within your software.

10-3. Mechanical Design

10-3-1. Each "Area"

Please confirm the following information before starting your design.

(a) Key Area

"Key Area" is an area where T/P specifications(Linearity,Durability,Actuation force, etc.) are guaranteed.

- 1) Do a touch data sensing and calibration inside this area.
- 2) In normal cases it is a same size as your flat display's "active area".
- 3) The ITO layer durability near the edge of Key area is less stronger than the center.

(b) Transparent Insulation-paste Area.

Insulation-paste is printed with 1.0 mm distance outer from "Key Area."

- 1) The purpose is to avoid potential shorting problem from the bezel housing edge from or housing "stick" when molding.
- 2) Consider your housing edge position to keep 1.0 mm distance from this paste line.
(See.Fig.1)
- 3) The cross section of this edge is taper shape. So if it is over the display's active area, it will be shining as a prism.

(c) Prohibition Area

Input by pen and finger is prohibited in this area.

Because of the thickness around T/P, the ITO layer on the PET film will be expanded and as a conclusion it will be cracked if pressed. (See.Fig.2)

- 1) We strongly recommend that the bezel should protect this area.
- 2) An exposure of this area and stylus contact should be avoided.
- 3) When assembling at the customer, do not press this area with tools.
- 4) Consider your design to avoid the pressure by the housing bezel.

10-3-2. Example of Housing Design.

- 1) If a consumer will put a palm on housing in normal usage care should be taken as follows.
- 2) Keep the gap, for example 0.3 to 0.7 mm, between bezel edge and T/P surface.
The reason is to avoid the bezel edge from contacting T/P surface that may cause a "short" with bottom layer. (See Fig. 1)
- 3) Insertion of a cushion material is recommended.
- 4) The cushion material should be limited just on the bulbar insulation past area.
If it is over the transparent insulation paste area a "short" may be occurred.
- 5) If there is a probability of the touch panel surface being exposed to water, steam or other liquids, then please take measures to ensure that the bezel / touch panel gap and housing are "water tight".
- 6) There is a vent channel to equalize air pressure between the inner space of the touch panel and the atmosphere. Please make sure it is not blocked by your housing and mounting method. There is also the possibility that moisture could percolate into the touch panel if moisture is allowed to accumulate around the air vent channel. Furthermore, avoid high air pressures inside your housing which could cause the touch panel outer surface to swell out from inflation.

10-3-3. Mounting on display and housing bezel

- 1) In all cases, the T/P should be supported from the backside of the glass.
- 2) Do not use an adhesive tape to bond it on the front of T/P and hang it to the housing bezel.
- 3) Never expand the T/P top layer (PET-film) like a balloon by internal air pressure.
The life of the T/P will be extremely short.
- 4) If a dew will be on the heat-sealed area or exposed traces at the end of a flexible tail, the migration of silver can occur.
This will cause sometimes a short circuit.

If your final product will be used in a humid circumstance or will be moved from humid, warm environments to cold ones, a dew condensation can occur.

Consider a water seal with your housing bezel.

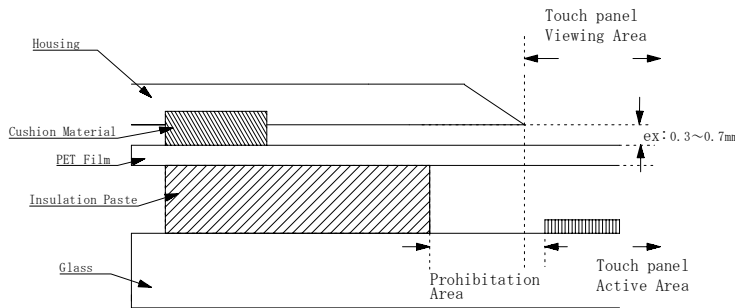

Fig. 1

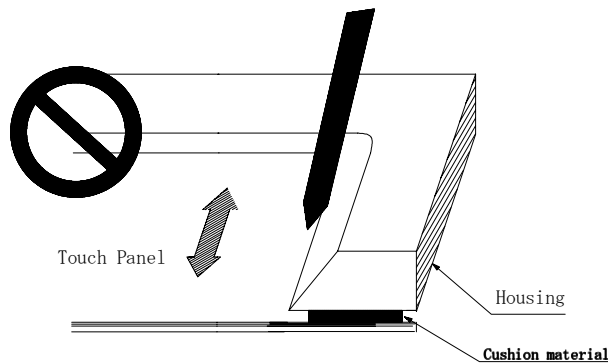
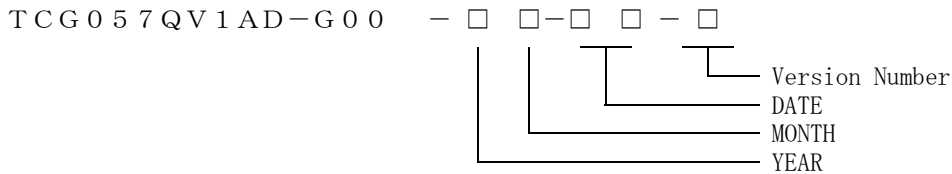

Fig. 2

1 1. Lot Number Identification

The lot number shall be indicated on the back of the backlight case of each LCD.



| | | | | | | |
|------|------|------|------|------|------|------|
| YEAR | 2004 | 2005 | 2006 | 2007 | 2008 | 2009 |
| CODE | 4 | 5 | 6 | 7 | 8 | 9 |

| | | | | | | |
|-------|------|------|------|------|------|------|
| MONTH | JAN. | FEB. | MAR. | APR. | MAY. | JUN. |
| CODE | 1 | 2 | 3 | 4 | 5 | 6 |

| | | | | | | |
|-------|------|------|------|------|------|------|
| MONTH | JUL. | AUG. | SEP. | OCT. | NOV. | DEC. |
| CODE | 7 | 8 | 9 | X | Y | Z |

1 2. Warranty

12-1. Incoming inspection

Please inspect the LCD within one month after your receipt.

12-2. Production Warranty

Kyocera warrants its LCDs for a period of 12 months after receipt by the purchaser, and within the limits specified. Kyocera shall, by mutual agreement, replace or rework defective LCDs that are shown to be Kyocera's responsibility.

1 3. Precautions for use

13-1. Installation of the LCD

1. In case of necessity due to environment to use LCD and countermeasure of noise, LCD is structured to have GND connection available. We recommend to use LCD to connect GND in order to stabilize a display performance.

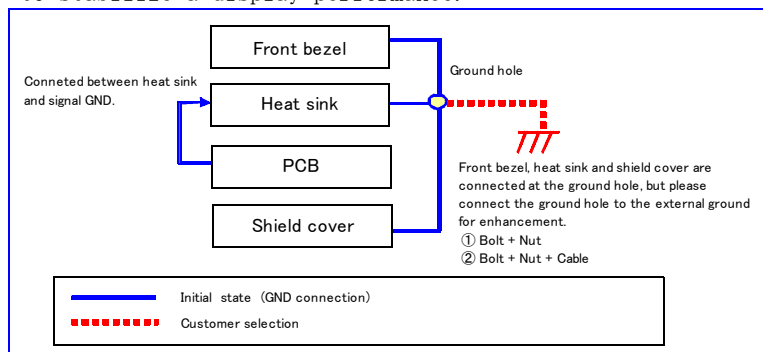

2. The LCD shall be installed so that there is no pressure on the LSI chips.
3. The LCD shall be installed flat, without twisting or bending.
4. The display window size should be the same as the effective viewing area.
5. In case you use outside frame of effective viewing area as outward appearance of your product, unevenness of its outward appearance is out of guarantee.
6. Do not pull the CFL lead wires and do not bend the root of the wires. Housing should be designed to protect CFL lead wires from external stress.
7. This Kyocera LCD module has been specifically designed for use in general electronic devices, but not for use in a special environment such as usage in an active gas. Hence, when the LCD is supposed to be used in a special environment, evaluate the LCD thoroughly beforehand and do not expose the LCD to chemicals such as an active gas.

13-2. Static Electricity

1. Since CMOS ICs are mounted directly onto the LCD glass, protection from static electricity is required. Operation should wear ground straps.

13-3. LCD Operation

1. The LCD shall be operated within the limits specified. Operation at values outside of these limits may shorten life, and/or harm display images.
2. Adjust "LCD driving voltage" to obtain optimum viewing angle and contrast.
3. Operation of the LCD at temperature below the limit specified may cause image degradation and/or bubbles.

It may also change the characteristics of the liquid crystal.

This phenomenon may not recover. The LCD shall be operated within the temperature limits specified.

13-4. Storage

1. The LCD shall be stored within the temperature and humidity limits specified. Store in a dark area, and protected the LCD from direct sunlight or fluorescent light.
2. Always store the LCD so that it is free from external pressure onto it.

13-5. Screen Surface

1. DO NOT store in a high humidity environment for extended periods.
Image degradation, bubbles, and/or peeling off of polarizer may result.
2. Do not push or rub the touch panel's surface with hard to sharp objects such as knives, or the touch panel may be scratched.
3. When the touch panel is dirty, gently wipe the surface with a soft cloth, sometimes moistened by mild detergent or alcohol. If a hazardous chemical is dropped on the touch panel by mistake, wipe it off right away to prevent human contact.
4. Touch panel edges are sharp. Handle the touch panel with enough care to prevent cuts.
5. Always keep the LCD free from condensation during testing.
Condensation may permanently spot or stain the polarizers.

1 4. Reliability Data / Environmental Test

| TEST ITEM | TEST CONDITION | TEST TIME | RESULT |
|--------------------------------|--|-------------------|---|
| High Temp. Atmosphere | 80°C | 240 h | Display Quality : No defect Display Function : No defect Current Consumption : No defect |
| Low Temp. Atmosphere | -30°C | 240 h | Low Temp. Bubble : None Solid Crystallization of Liquid Crystal : None Display Quality : No defect Display Function : No defect Current Consumption : No defect |
| High Temp. Humidity Atmosphere | 40°C 90 %RH | 240 h | Display Quality : No defect Display Function : No defect Peel-off of Organic Sealing : None Current Consumption : No defect |
| Temp. Cycle | -30°C 0.5 h R.T. 0.5 h 80°C 0.5 h | 10 cycles | Display Quality : No defect Display Function : No defect Peel-off of Organic Sealing : None Bubble on Cell : None |
| High Temp. Operation | 70°C | 500 h | Display Quality : No defect Current Consumption : No defect |
| Point Activation life | Polyacetal stylus (R0.8) Hitting force 3N Hitting speed 2 time/s | one million times | Satisfy the spec • Terminal resistance • Insulation resistance • Linearity • Actuation Force |

- * Each test item uses a test LCD only once. The tested LCD is not used in any other tests.
- * The LCD is tested in circumstances in which there is no condensation.
- * The tested LCD is inspected after 24 hours of storage at room temperature and room humidity after each test is finished.
- * The reliability test is not an out-going inspection.
- * The results of the reliability test are for your reference purpose only.
The reliability test is conducted only to examine the LCD's capability.

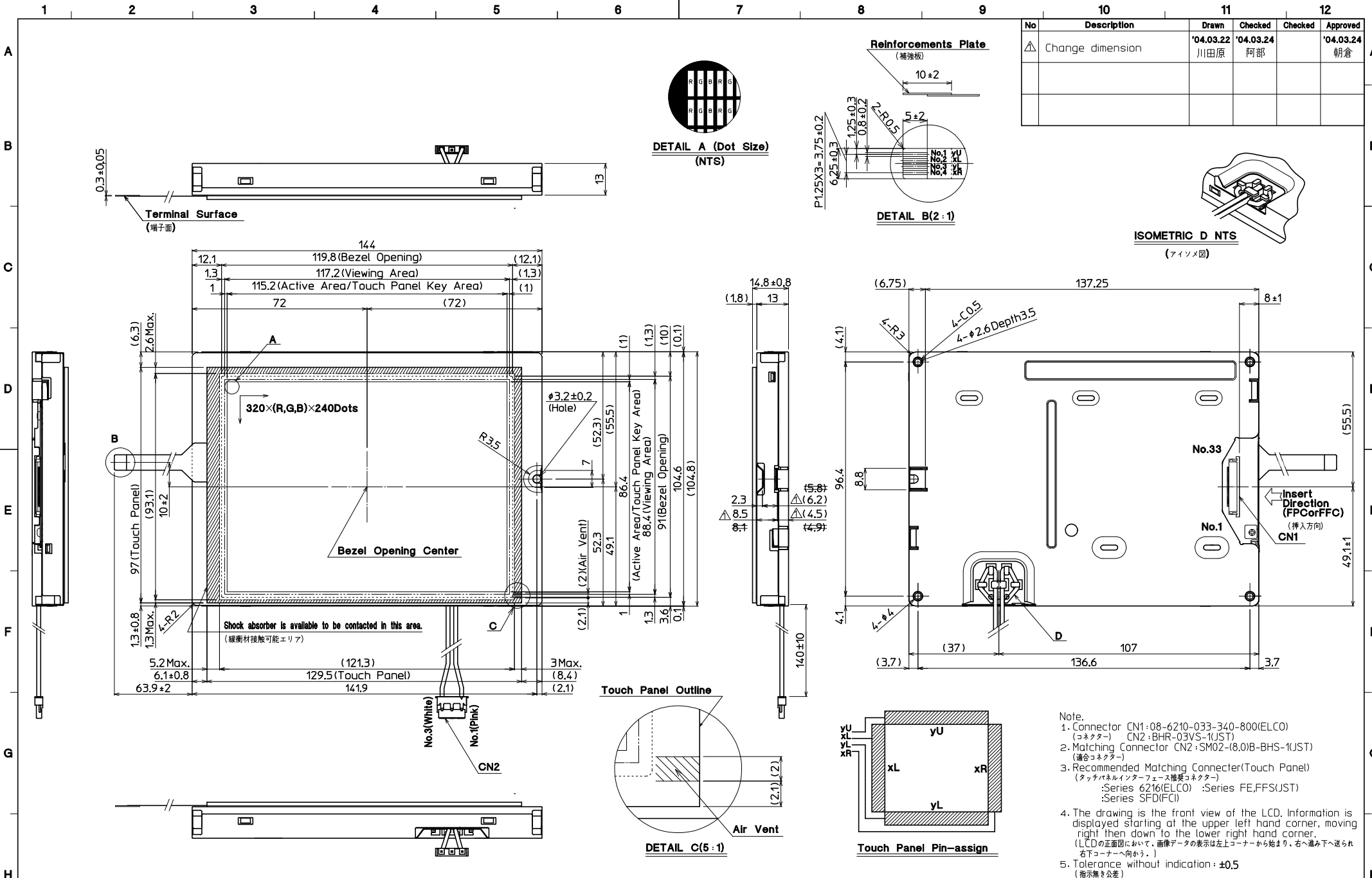

| No | Description | Drawn | Checked | Checked | Approved |
|----|------------------|------------------|-----------------|---------|-----------------|
| △ | Change dimension | '04.03.22 川田原 | '04.03.24 阿部 | | '04.03.24 朝倉 |
| | | | | | |
| | | | | | |

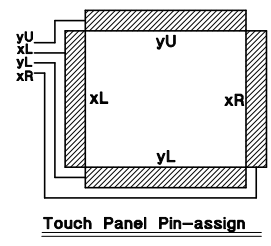
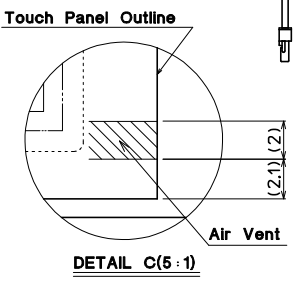
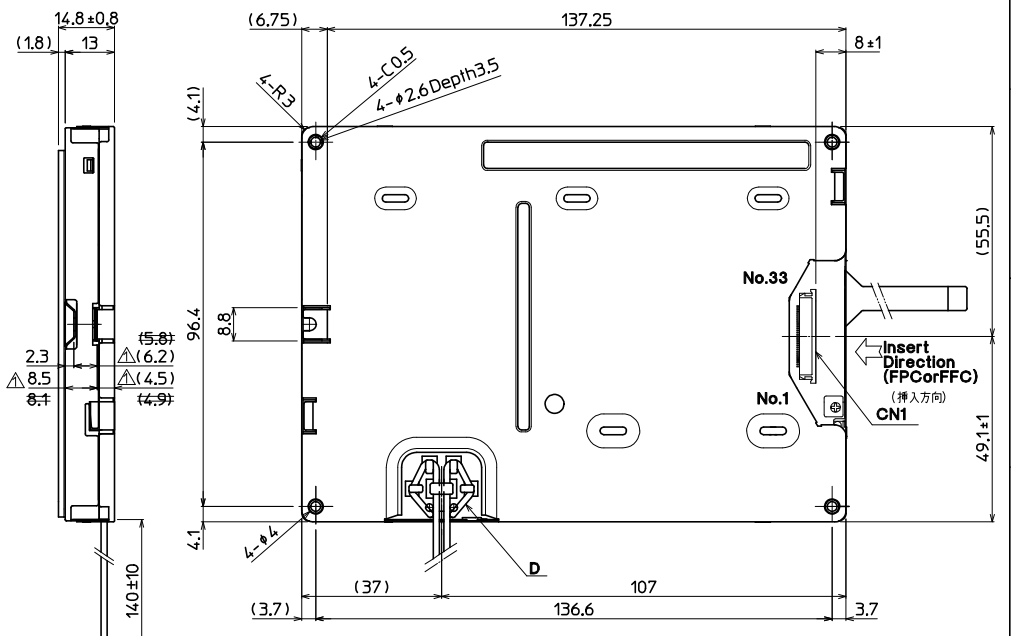
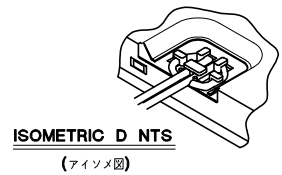
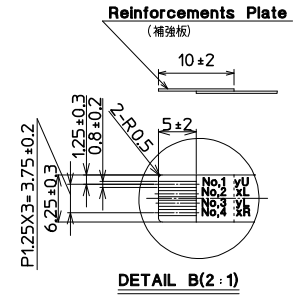
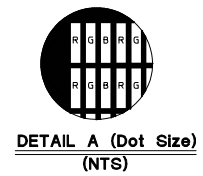

- Note.
- Connector CN1: 08-6210-033-340-800(ELCO) (コネクタ) CN2: BHR-03VS-1(JST) (適合コネクタ)
 - Matching Connector CN2: SM02-(8.0)B-BHS-1(JST) (適合コネクタ)
 - Recommended Matching Connector(Touch Panel) (タッチパネルインターフェース推奨コネクタ)
:Series 6216(ELCO) :Series FE,FFS(JST)
:Series SFD(FCI)
 - The drawing is the front view of the LCD. Information is displayed starting at the upper left hand corner, moving right then down to the lower right hand corner. (LCDの正面図において、画像データの表示は左上コーナーから始まり、右へ進み下へ進み、右下コーナーへ向かう。)
 - Tolerance without indication: ±0.5 (指示無き公差)

| | | | | | | | | | |
|-----------------|-------------------|-----------------------|----------------------|----------------------|--------------|-------------------------------|----------------------|------------------------------|-----------|
| Material 材質 | Treatment 処理 | Approved '04.03.08 | Checked '04.03.08 | Checked '04.03.08 | Drawn 川田原 | Scale 1:1(2:1) 5:1(NTS) | Title TCG057QV1AD | Year-Month-Day '04.03.03 | Size 2 |
| Quantity 製作数 | Description 備考 | 04015AAB | 朝倉 | 阿部 | 倉元 | | Outline Dimensions | Drawing No. 121A5028600-1 | |

| | |
|-----------|-----------------------|
| SPEC. NO. | TQ3C-8EAF0-E2DDE08-00 |
| DATE | September 29, 2004 |

FOR : _____

KYOCERA INSPECTION STANDARD

TYPE : TCG057QV1AD-G00

KYOCERA CORPORATION
KAGOSHIMA HAYATO PLANT
LCD DIVISION

| | | | | | |
|--------------------|--------------------------------|--------------------|--------------------|------------------------|------------------|
| Original | Designed by :Engineering Dept. | | | Confirmed by :QA Dept. | |
| Issue Data | Prepared | Checked | Approved | Checked | Approved |
| September 29, 2004 | <i>T. Onodera</i> | <i>H. Yamagaki</i> | <i>M. Fujitani</i> | <i>Y. Yoshida</i> | <i>T. Minami</i> |

Revision Record

| Date | Designed by: Engineering Dept. | | | Confirmed by: QA Dept. | |
|----------|--------------------------------|---------|--------------|------------------------|----------|
| | Prepared | Checked | Approved | Checked | Approved |
| | | | | | |
| Rev. No. | Date | Page | Descriptions | | |
| | | | | | |

1) Note

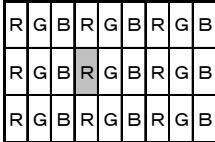
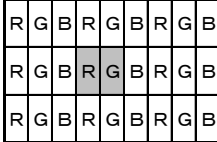
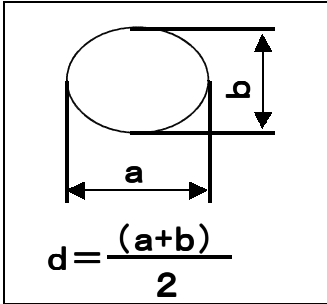
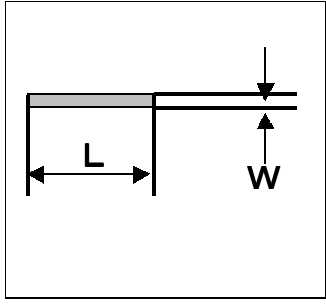
| | | Note | | |
|-------------------------------|---|--|--|--|
| General | <p>1. Customer identified anomalies not defined within this inspection standard shall be reviewed by Kyocera, and an additional standard shall be determined by mutual consent.</p> <p>2. Inspection Conditions Luminance : 500 Lux minimum Inspection distance : 300 mm (from the sample) Temperature : 25 ± 5 °C Direction : directly above</p> | | | |
| Definition of Inspection item | Dot defect | Bright dot defect | <p>The dot is constantly "on" when power applied to the LCD, even when all "Black" data sent to the screen. Inspection tool: 5% Transparency neutral density filter. Count dot: If the dot is visible through the filter Don't count dot: If the dot is not visible through the filter.</p>  <p style="text-align: right;">■ dot defect</p> | |
| | | Black dot defect | <p>The dot is constantly "off" when power applied to the LCD, even when all "white" data sent to the screen.</p> | |
| | | Adjacent dot | <p>Adjacent dot defect is defined as two or more bright dot defects or black dot defects.</p>  <p style="text-align: right;">■ dot defect</p> | |
| | External inspection | Bubble, Scratches, Foreign particle (Polarizer, Cell, Backlight) | Visible operating (all pixels "Black" or "White") and non operating. | |
| | | Appearance inspection | Does not satisfy the value at the spec. | |
| | Others | CFL wires | Damaged to the CFL wires, connector, pin, functional failure or appearance failure. | |
| | Definition of size | <p>Definition of circle size</p>  <p style="text-align: center;">$d = \frac{(a+b)}{2}$</p> | <p>Definition of linear size</p>  | |

2) Standard

| Classification | | Inspection item | Judgement standard | | | | | | | | | | | | | | | | |
|--|--|--|---|-----------------------|-------------------|-------------------|-------------------|--------------------|--------------------|---------------------|--------------------|--------------------|--------------------|-------------|-----------|---|-----------|---|----------------------------------|
| defect (in LCD glass) | Dot defect | Bright dot defect | Acceptable number : 4 bright dots defects Bright dot spacing : 5 mm or more | | | | | | | | | | | | | | | | |
| | | Black dot defect | Acceptable number : 5 black dots defects Black dot spacing : 5 mm or more | | | | | | | | | | | | | | | | |
| | | 2 dots join | Bright dot defect | Acceptable number : 2 | | | | | | | | | | | | | | | |
| | | | Black dot defect | Acceptable number : 3 | | | | | | | | | | | | | | | |
| | | 3 or more dots join | Acceptable number : 0 | | | | | | | | | | | | | | | | |
| | Total dot defects | Acceptable number : 5 Max | | | | | | | | | | | | | | | | | |
| | Others | White dot, Dark dot (Circle) | <table border="1"> <thead> <tr> <th>Size(mm)</th> <th>Acceptable Number</th> </tr> </thead> <tbody> <tr> <td>$d < 0.2$</td> <td>(neglected)</td> </tr> <tr> <td>$0.2 < d \leq 0.4$</td> <td>5</td> </tr> <tr> <td>$0.4 < d \leq 0.5$</td> <td>3</td> </tr> <tr> <td>$0.5 < d$</td> <td>0</td> </tr> </tbody> </table> | | | Size(mm) | Acceptable Number | $d < 0.2$ | (neglected) | $0.2 < d \leq 0.4$ | 5 | $0.4 < d \leq 0.5$ | 3 | $0.5 < d$ | 0 | | | | |
| Size(mm) | Acceptable Number | | | | | | | | | | | | | | | | | | |
| $d < 0.2$ | (neglected) | | | | | | | | | | | | | | | | | | |
| $0.2 < d \leq 0.4$ | 5 | | | | | | | | | | | | | | | | | | |
| $0.4 < d \leq 0.5$ | 3 | | | | | | | | | | | | | | | | | | |
| $0.5 < d$ | 0 | | | | | | | | | | | | | | | | | | |
| External inspection (Defect on Polarizer or between Polariz- er and LCD glass) | Polarizer(Scratches) | <table border="1"> <thead> <tr> <th>Width(mm)</th> <th>Length(mm)</th> <th>Acceptable Number</th> </tr> </thead> <tbody> <tr> <td>$W \leq 0.1$</td> <td>-</td> <td>(neglected)</td> </tr> <tr> <td rowspan="2">$0.1 < W \leq 0.3$</td> <td>$L \leq 5.0$</td> <td>(neglected)</td> </tr> <tr> <td>$5.0 < L$</td> <td>0</td> </tr> <tr> <td>$0.3 < W$</td> <td>-</td> <td>0</td> </tr> </tbody> </table> | | | | Width(mm) | Length(mm) | Acceptable Number | $W \leq 0.1$ | - | (neglected) | $0.1 < W \leq 0.3$ | $L \leq 5.0$ | (neglected) | $5.0 < L$ | 0 | $0.3 < W$ | - | 0 |
| | | Width(mm) | Length(mm) | Acceptable Number | | | | | | | | | | | | | | | |
| | | $W \leq 0.1$ | - | (neglected) | | | | | | | | | | | | | | | |
| | | $0.1 < W \leq 0.3$ | $L \leq 5.0$ | (neglected) | | | | | | | | | | | | | | | |
| | $5.0 < L$ | | 0 | | | | | | | | | | | | | | | | |
| | $0.3 < W$ | - | 0 | | | | | | | | | | | | | | | | |
| | Polarizer Touch panel (Bubble, Dent) | <table border="1"> <thead> <tr> <th>Size(mm)</th> <th>Acceptable Number</th> </tr> </thead> <tbody> <tr> <td>$d < 0.2$</td> <td>(neglected)</td> </tr> <tr> <td>$0.2 < d \leq 0.3$</td> <td>5</td> </tr> <tr> <td>$0.3 < d \leq 0.5$</td> <td>3</td> </tr> <tr> <td>$0.5 < d$</td> <td>0</td> </tr> </tbody> </table> | | | Size(mm) | Acceptable Number | $d < 0.2$ | (neglected) | $0.2 < d \leq 0.3$ | 5 | $0.3 < d \leq 0.5$ | 3 | $0.5 < d$ | 0 | | | | | |
| | | Size(mm) | Acceptable Number | | | | | | | | | | | | | | | | |
| | | $d < 0.2$ | (neglected) | | | | | | | | | | | | | | | | |
| | | $0.2 < d \leq 0.3$ | 5 | | | | | | | | | | | | | | | | |
| $0.3 < d \leq 0.5$ | 3 | | | | | | | | | | | | | | | | | | |
| $0.5 < d$ | 0 | | | | | | | | | | | | | | | | | | |
| Foreign Particle(Circular shape) | <table border="1"> <thead> <tr> <th>Size(mm)</th> <th>Acceptable Number</th> </tr> </thead> <tbody> <tr> <td>$d < 0.2$</td> <td>(neglected)</td> </tr> <tr> <td>$0.2 < d \leq 0.4$</td> <td>5</td> </tr> <tr> <td>$0.4 < d \leq 0.5$</td> <td>3</td> </tr> <tr> <td>$0.5 < d$</td> <td>0</td> </tr> </tbody> </table> | | | Size(mm) | Acceptable Number | $d < 0.2$ | (neglected) | $0.2 < d \leq 0.4$ | 5 | $0.4 < d \leq 0.5$ | 3 | $0.5 < d$ | 0 | | | | | | |
| | Size(mm) | Acceptable Number | | | | | | | | | | | | | | | | | |
| | $d < 0.2$ | (neglected) | | | | | | | | | | | | | | | | | |
| | $0.2 < d \leq 0.4$ | 5 | | | | | | | | | | | | | | | | | |
| $0.4 < d \leq 0.5$ | 3 | | | | | | | | | | | | | | | | | | |
| $0.5 < d$ | 0 | | | | | | | | | | | | | | | | | | |
| Foreign Particle (Linear shape), Scratches | <table border="1"> <thead> <tr> <th>Width(mm)</th> <th>Length(mm)</th> <th>Acceptable Number</th> </tr> </thead> <tbody> <tr> <td>$W \leq 0.03$</td> <td>-</td> <td>(neglected)</td> </tr> <tr> <td rowspan="3">$0.03 < W \leq 0.1$</td> <td>$L \leq 2.0$</td> <td>(neglected)</td> </tr> <tr> <td>$2.0 < L \leq 4.0$</td> <td>3</td> </tr> <tr> <td>$4.0 < L$</td> <td>0</td> </tr> <tr> <td>$0.1 < W$</td> <td>-</td> <td>(According to Circular shape)</td> </tr> </tbody> </table> | | | Width(mm) | Length(mm) | Acceptable Number | $W \leq 0.03$ | - | (neglected) | $0.03 < W \leq 0.1$ | $L \leq 2.0$ | (neglected) | $2.0 < L \leq 4.0$ | 3 | $4.0 < L$ | 0 | $0.1 < W$ | - | (According to Circular shape) |
| | Width(mm) | Length(mm) | Acceptable Number | | | | | | | | | | | | | | | | |
| | $W \leq 0.03$ | - | (neglected) | | | | | | | | | | | | | | | | |
| | $0.03 < W \leq 0.1$ | $L \leq 2.0$ | (neglected) | | | | | | | | | | | | | | | | |
| | | $2.0 < L \leq 4.0$ | 3 | | | | | | | | | | | | | | | | |
| $4.0 < L$ | | 0 | | | | | | | | | | | | | | | | | |
| $0.1 < W$ | - | (According to Circular shape) | | | | | | | | | | | | | | | | | |

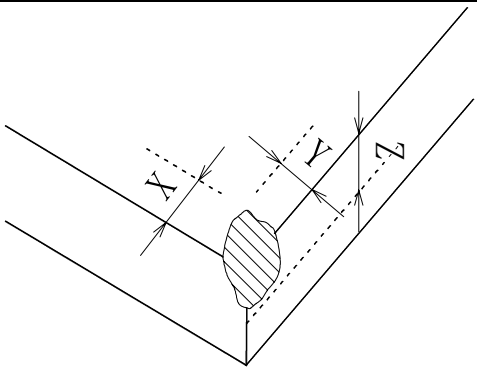
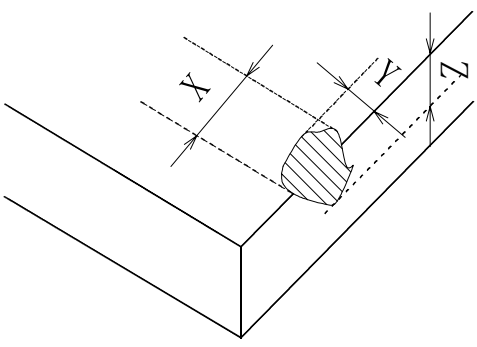
| Classification | Inspection item | Judgement standard | | |
|---|---|--|------------|-------------------|
| Touch Screen portion | Scratch | Width(mm) | Length(mm) | Acceptable number |
| | | W < 0.05 | 10 < L | neglected |
| | | 0.05 ≤ W < 0.10 | | 3 |
| | | 0.10 ≤ W | | 0 |
| | Glass crack (Corner crack) |  | | |
| | X | Y | Z | |
| | OK ≤ 3 | OK ≤ 3 | OK ≤ t | |
| | <ul style="list-style-type: none"> • If one of X, Y, Z is not satisfied, it is regarded as NG. • Regarding the corner crack, within 0.5 mm depth is regarded as OK. (t= thickness of Touch panel) | | | |
| | Glass crack (Cracks in other area than in corner) |  | | |
| | X | Y | Z | |
| OK ≤ 3 | OK ≤ 3 | OK ≤ t | | |
| <ul style="list-style-type: none"> • If one of X, Y, Z is not satisfied, it is regarded as NG. • Regarding the corner crack, within 0.5 mm depth is regarded as OK. (t= thickness of Touch panel) | | | | |
| | | | | |